

Fitting Instruction





Clip On Soft Tonneau Cover

Part No. ATC1740

Mitsubishi MQ/ MR Triton Daul Cab
With Factory Sports Bar Model
(Genuine Hardware Fitted)

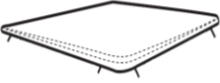
Installation Instruction

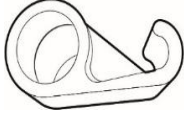
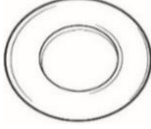
Parts Supplied

Tonneau Cover x 1	Shock Cord x 1	Rope Hook x 7	Washer x 2	Fitting Instruction x 1
				

1. Fit The Tonneau Cover

- Attach the four plastic “J” Retainer on the front of the Tonneau Cover to rope track channel. *See Figure 1*
- Pull the cover over the support bar and drape the cover across the tub.
- Clip the side plastics under the aluminium profile first using the pull loops in the corners to stretch the cover.
- Clip the plastic on the tailgate under the aluminium profile last. *See Figure 2*

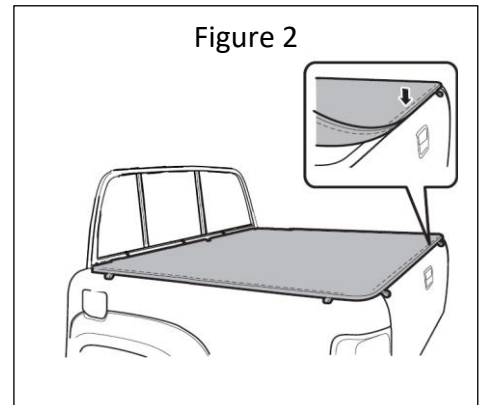
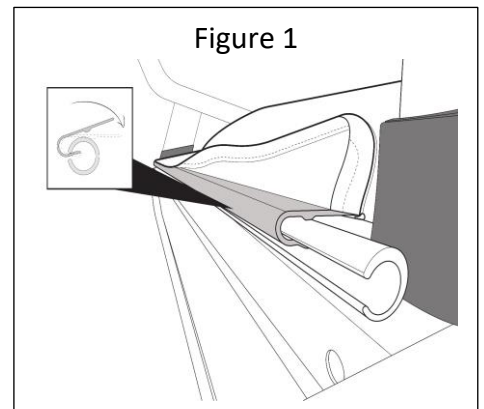

Using Internal Elastic Shock Cord:

The plastic clips on the internal shock cord can be hooked into the aluminium extrusions so that the cover can still be secured with larger loads in the tub.

Your Tonneau is ready for work.

2. How To Fit Internal Shock Cord

- a. Tie a knot in one end of the shock cord
- b. Pull shock cord through all the plastic hooks.
- c. Feed the shock cord through the loops on the cover.
- d. Tie a knot at the other end.
- e. Space the hooks as required.
- f. Use washers to tie off the shock cord.

