

# **Fitting Instruction**





Clip On Soft Tonneau Cover

Part No. ATC01730

Mitsubishi MQ/ MR Triton Daul Cab  
With Headboard Model  
(Genuine Hardware Fitted)

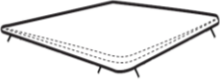
# Installation Instruction

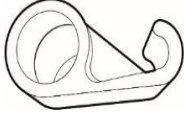
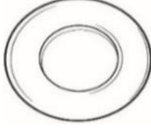
## Parts Supplied

Tonneau Cover x 1	Shock Cord x 1	Rope Hook x 7	Washer x 2	Fitting Instruction x 1
				

## 1. Fit The Tonneau Cover

- Attach the four plastic “J” Retainer on the front of the Tonneau Cover to rope track channel. *See Figure 1*
- Pull the cover over the support bar and drape the cover across the tub.
- Clip the side plastics under the aluminium profile first using the pull loops in the corners to stretch the cover.
- Clip the plastic on the tailgate under the aluminium profile last. *See Figure 2*

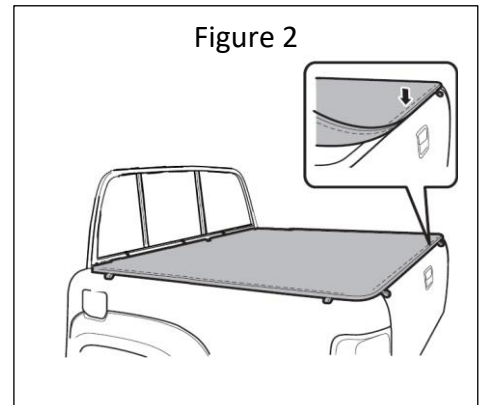
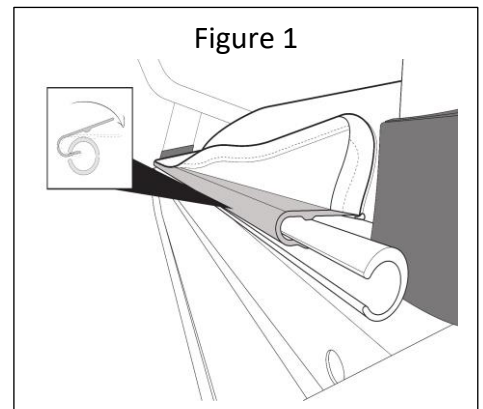

### Using Internal Elastic Shock Cord:

The plastic clips on the internal shock cord can be hooked into the aluminium extrusions so that the cover can still be secured with larger loads in the tub.

**Your Tonneau is ready for work.**

## 2. How To Fit Internal Shock Cord

- a. Tie a knot in one end of the shock cord
- b. Pull shock cord through all the plastic hooks.
- c. Feed the shock cord through the loops on the cover.
- d. Tie a knot at the other end.
- e. Space the hooks as required.
- f. Use washers to tie off the shock cord.

